

VISTA
1

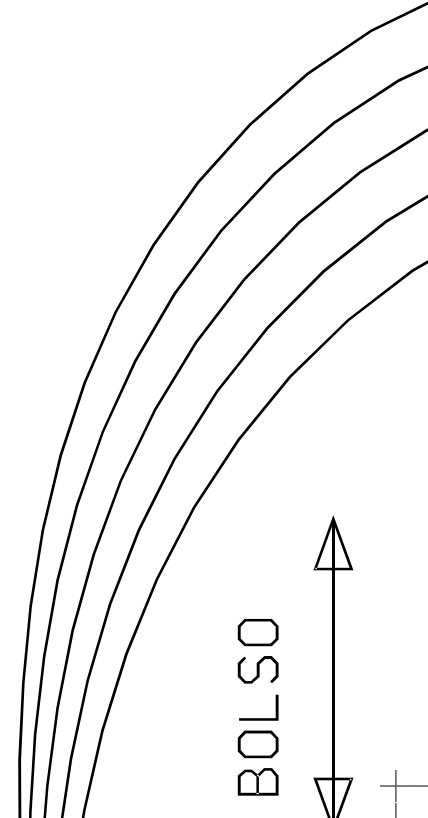

BOLSO

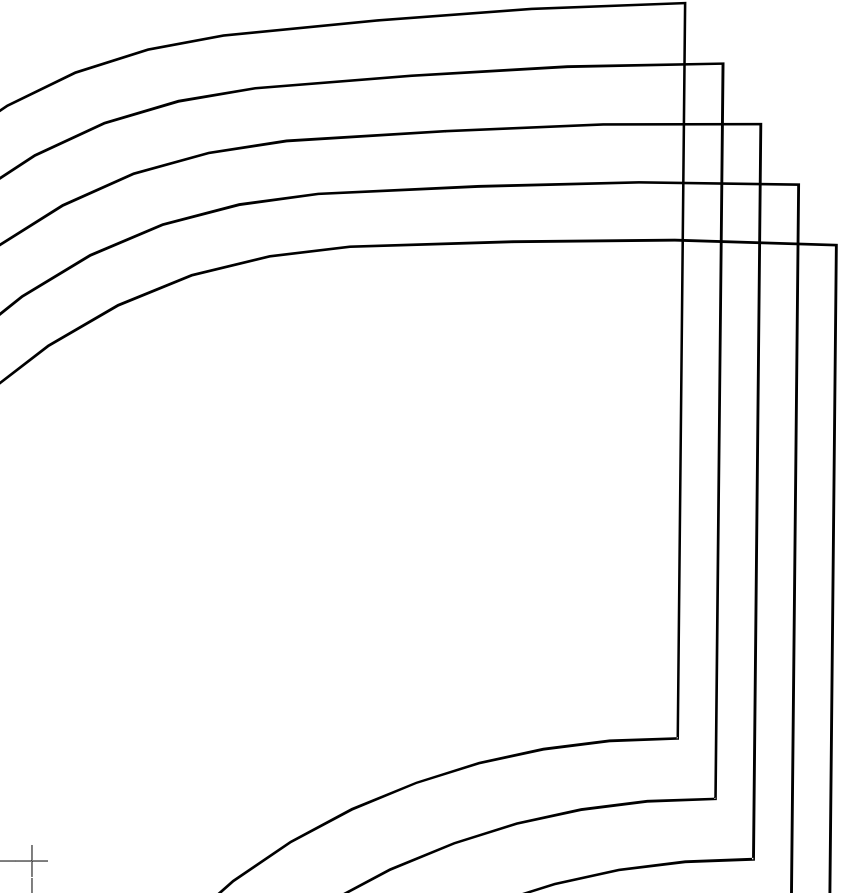

2

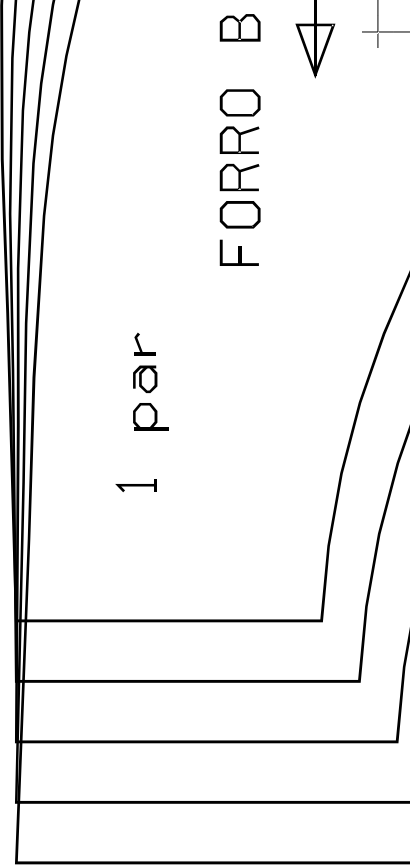
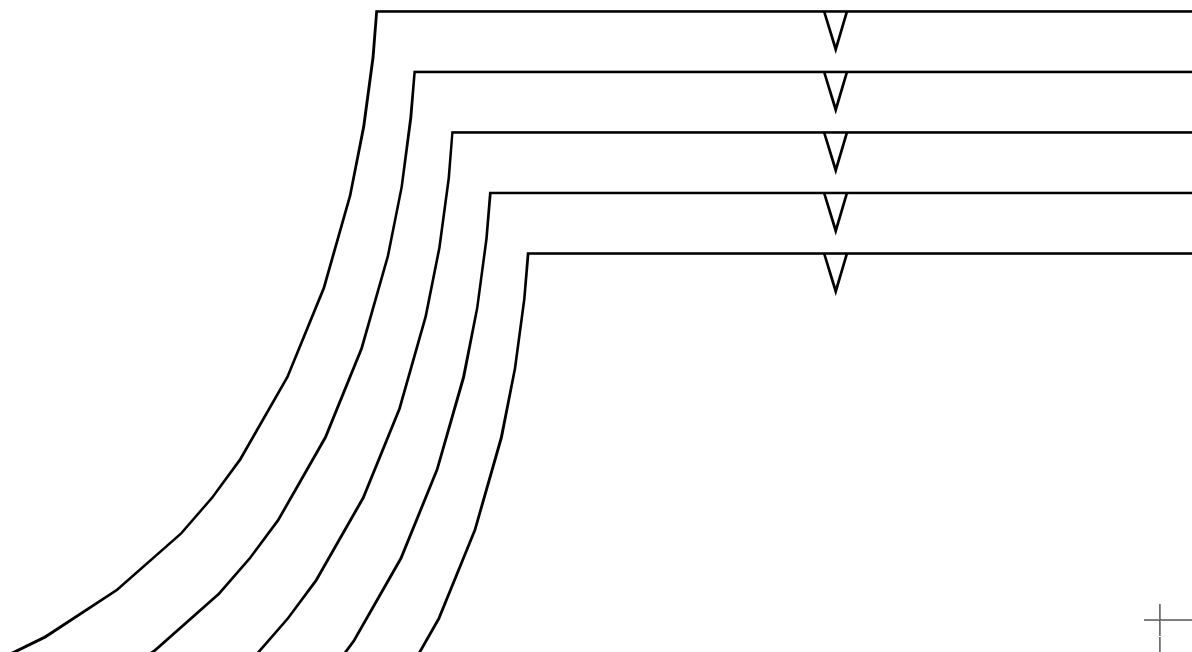
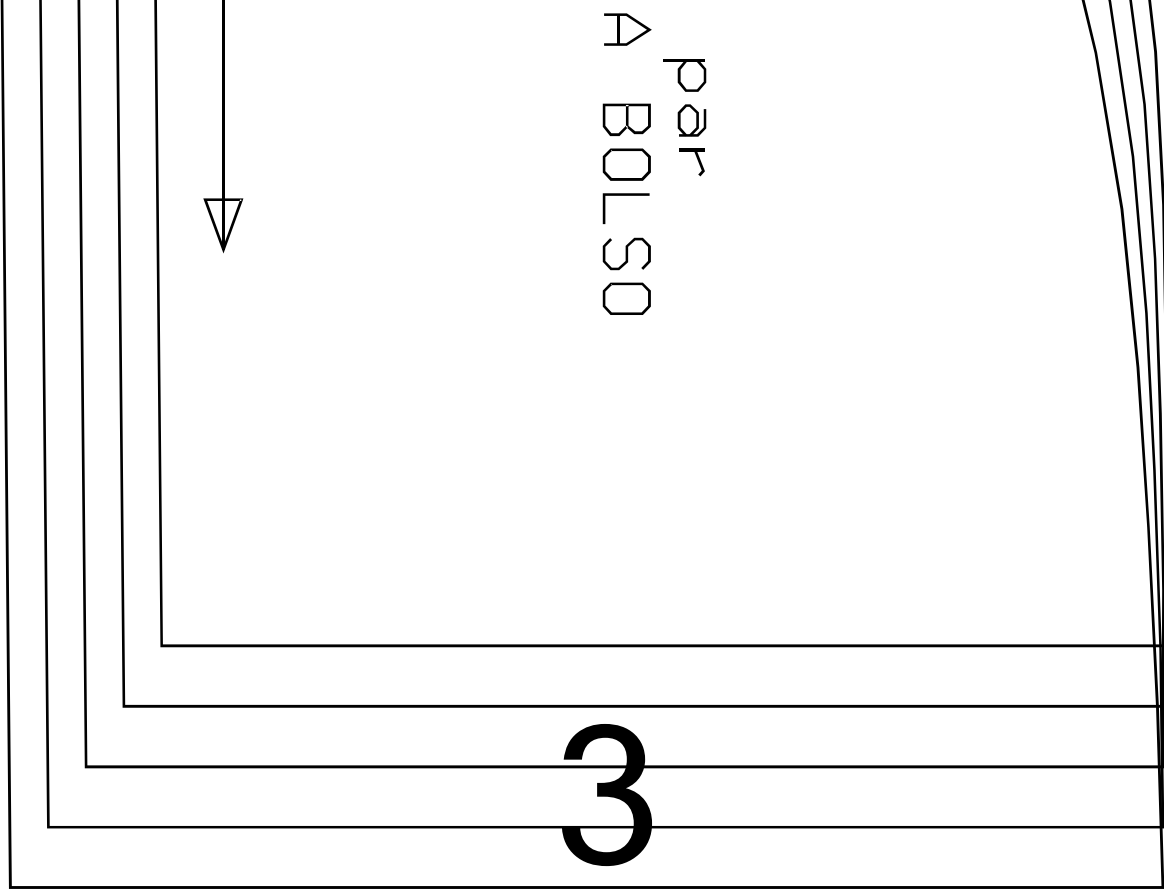

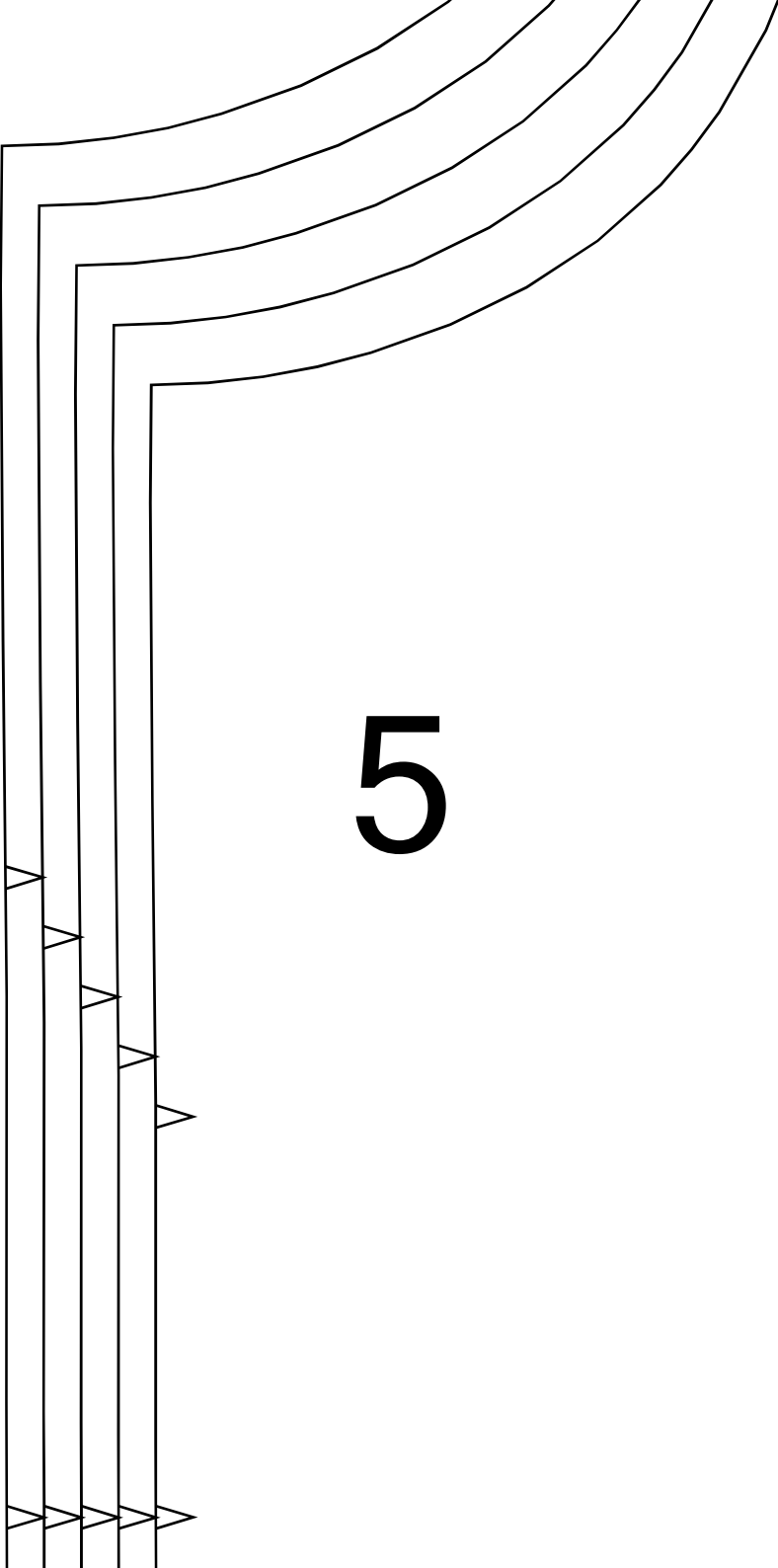

5

1 par

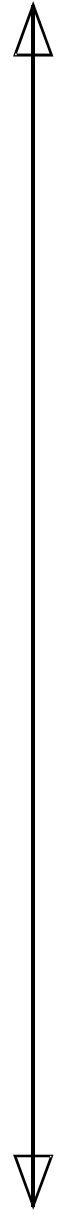

DIANTEIRO

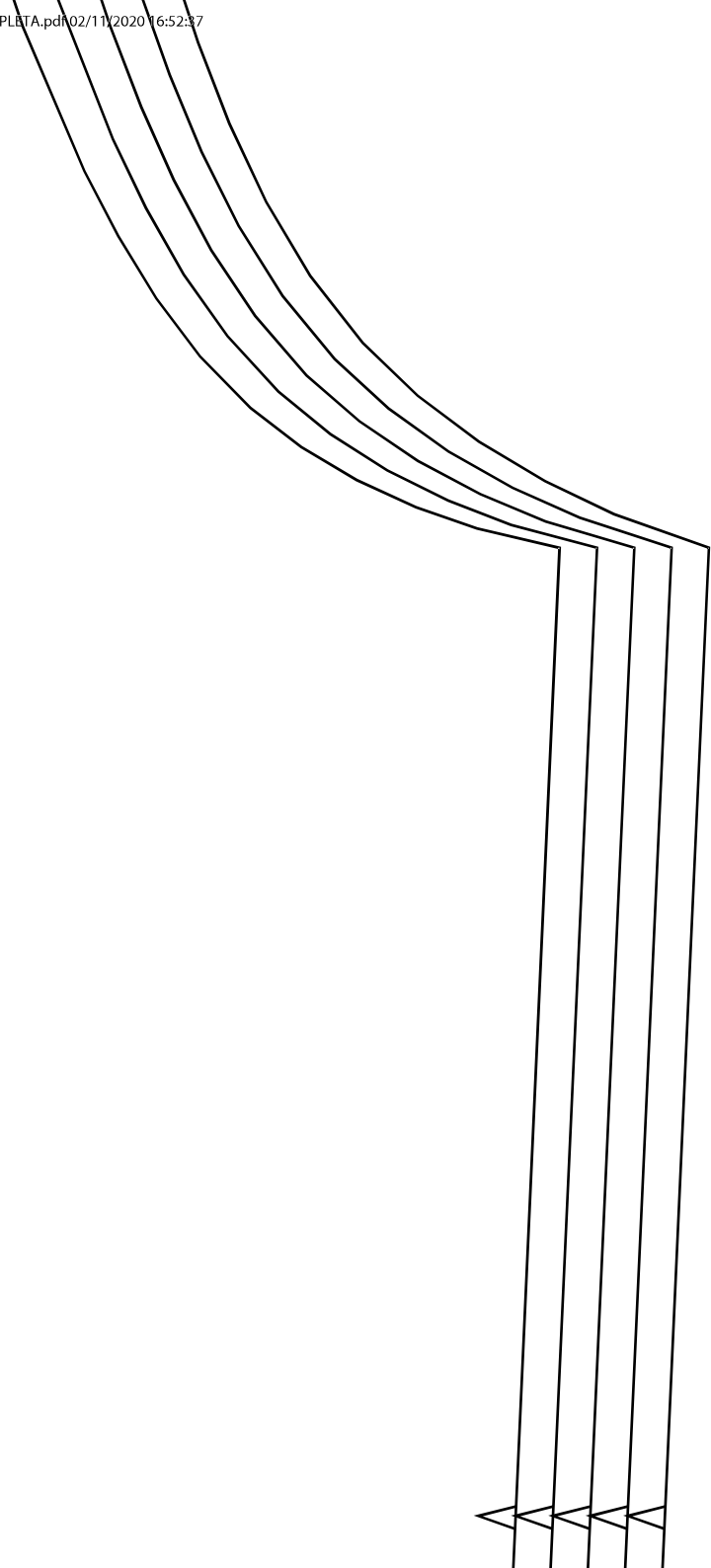

6

COS
1 x

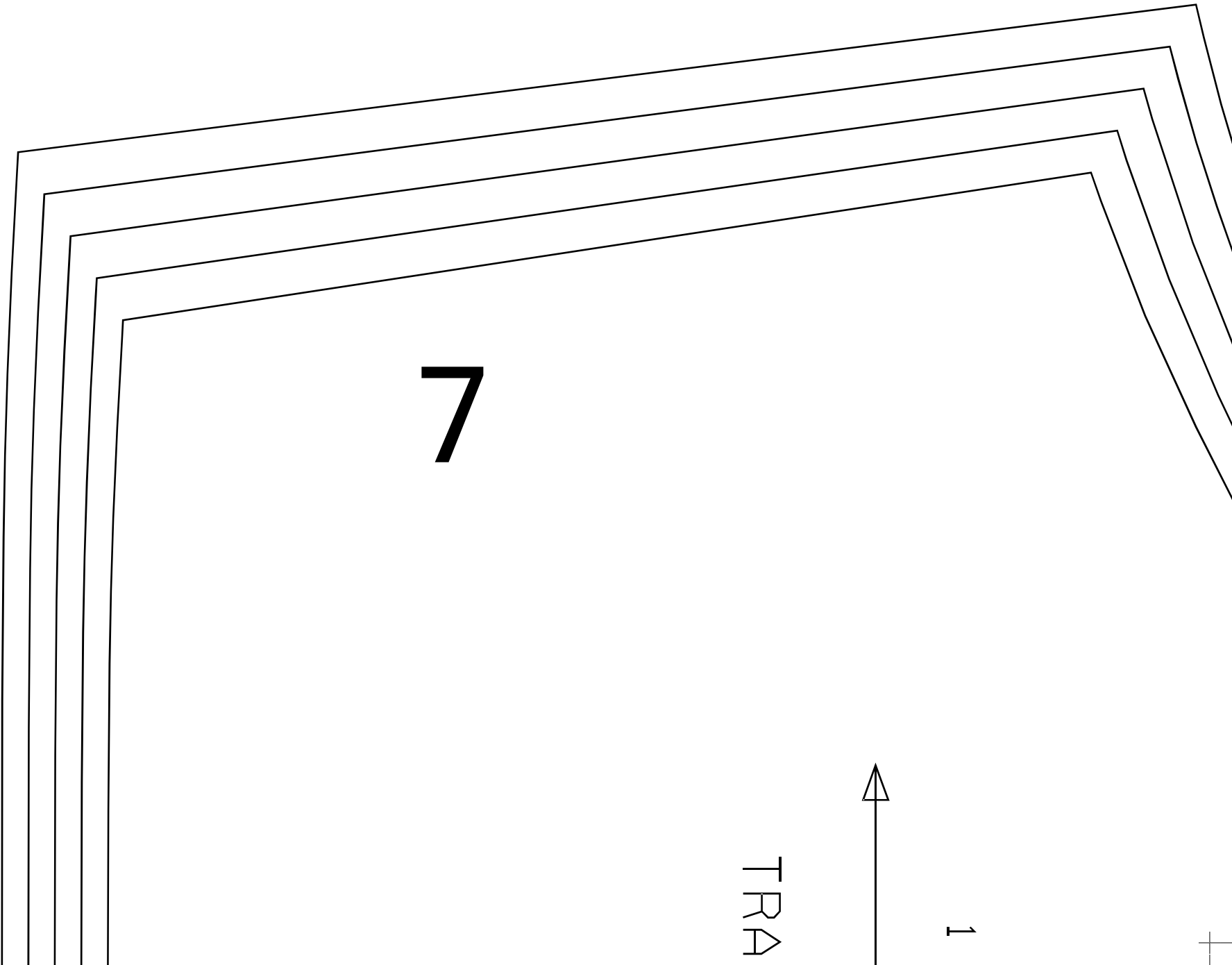
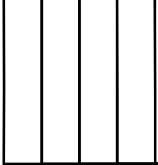

7

TRA



1

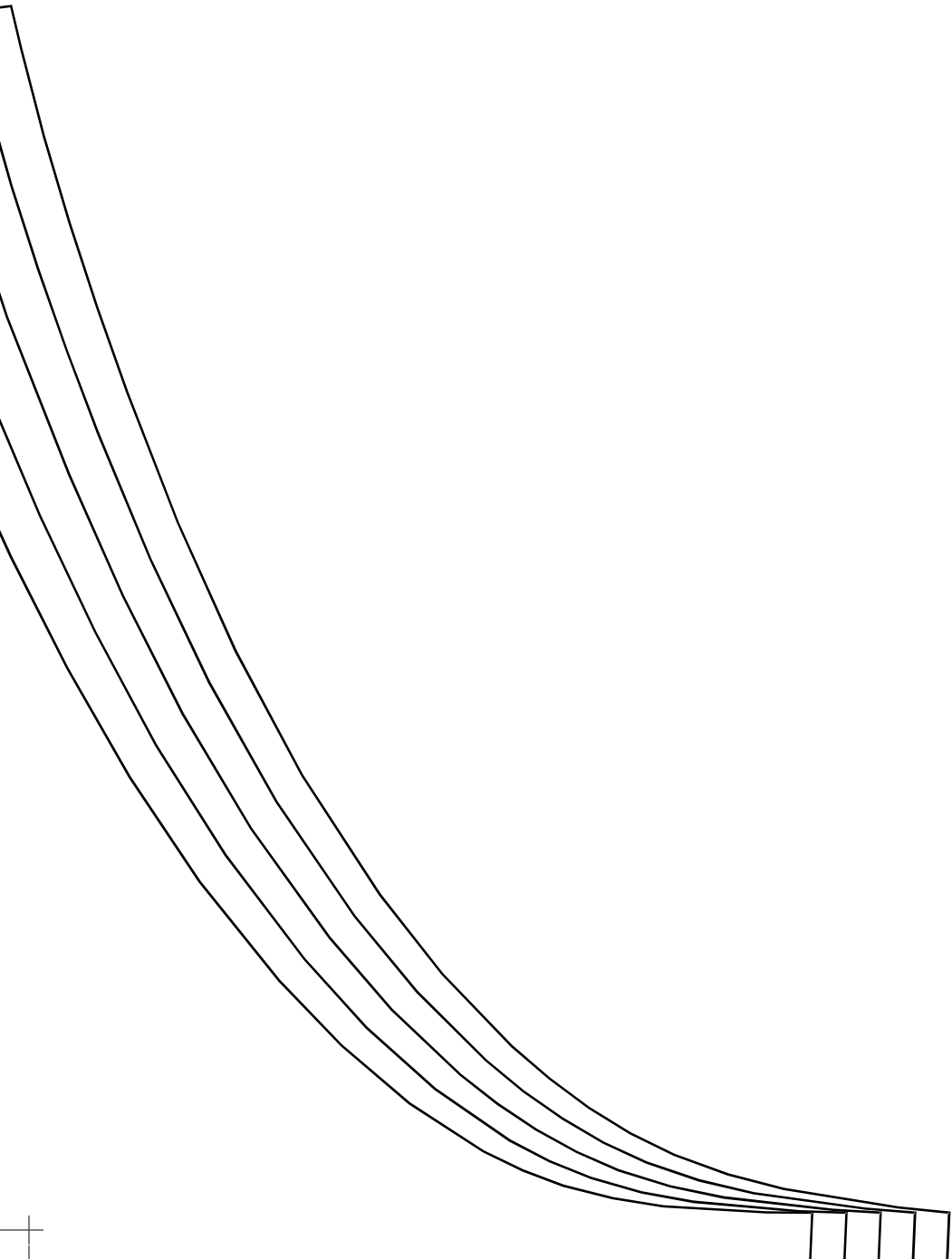

8

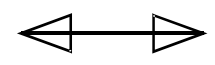

par



ASEIRO

9

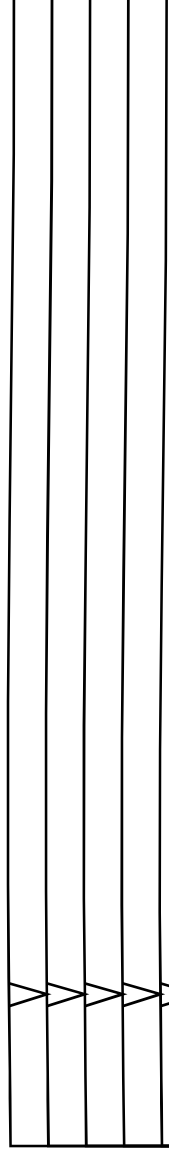

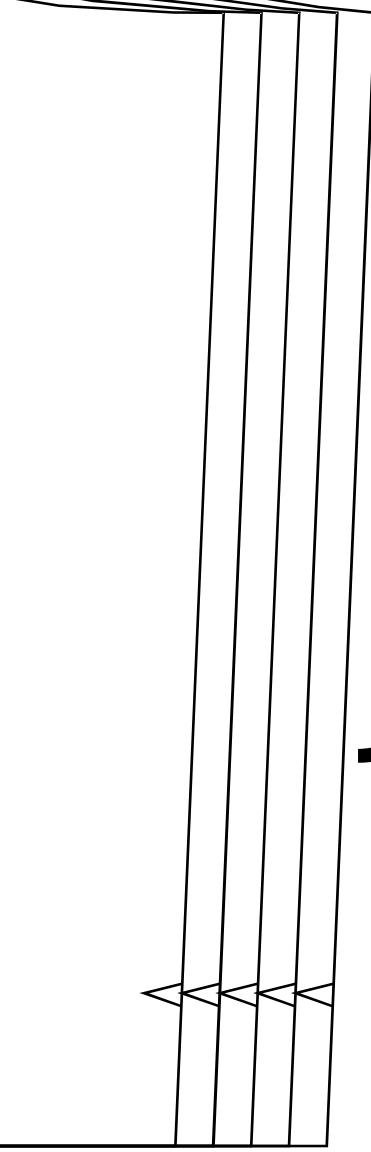

10

