

	1	r ar
		r ar

qop

2

qop

x2

3



4

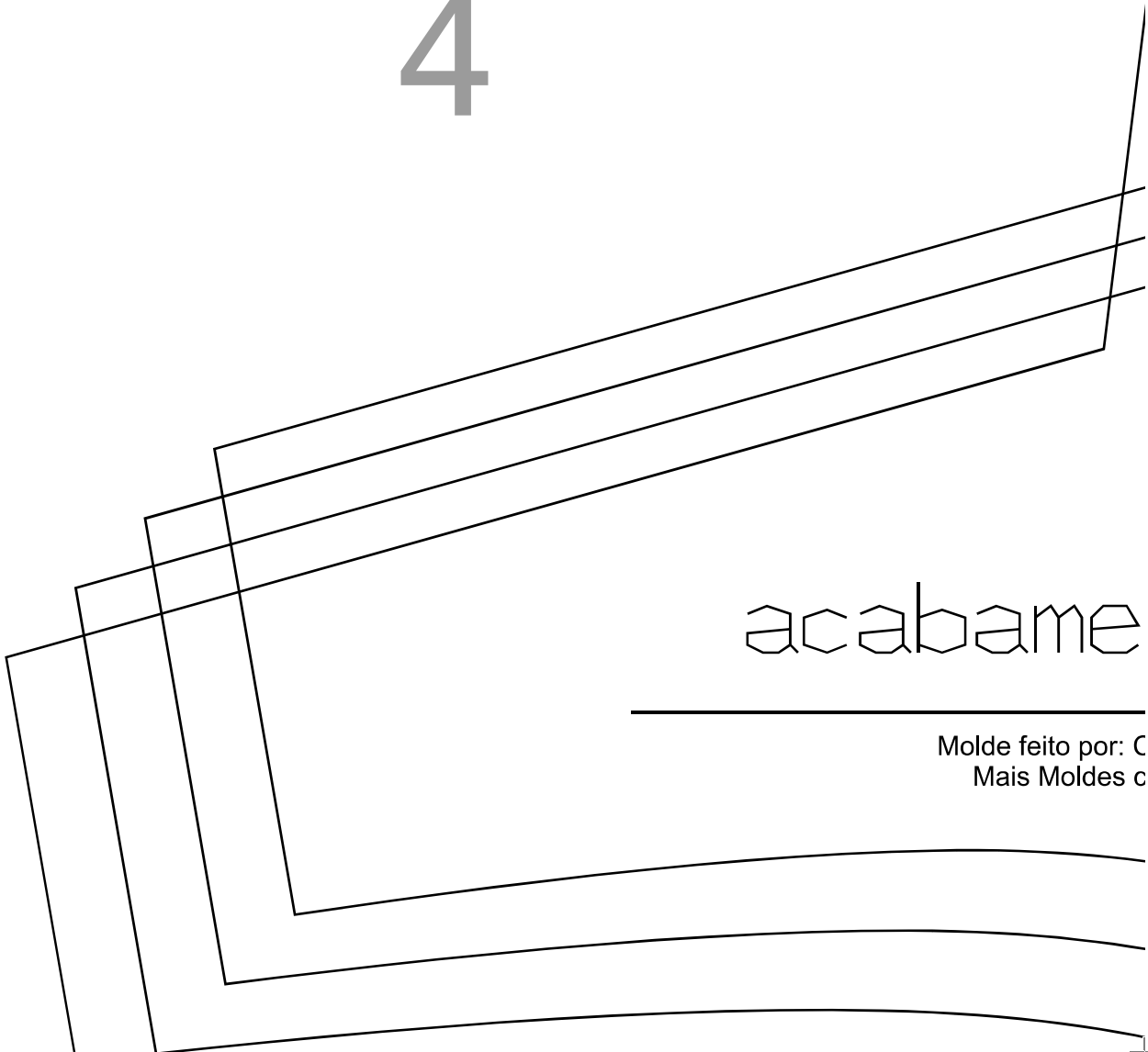

acabame

Molde feito por: C
Mais Moldes c



2x5

frente

Carla Oliveira | Modelista Profissional ©
como este acesse gmmoldes.com.br

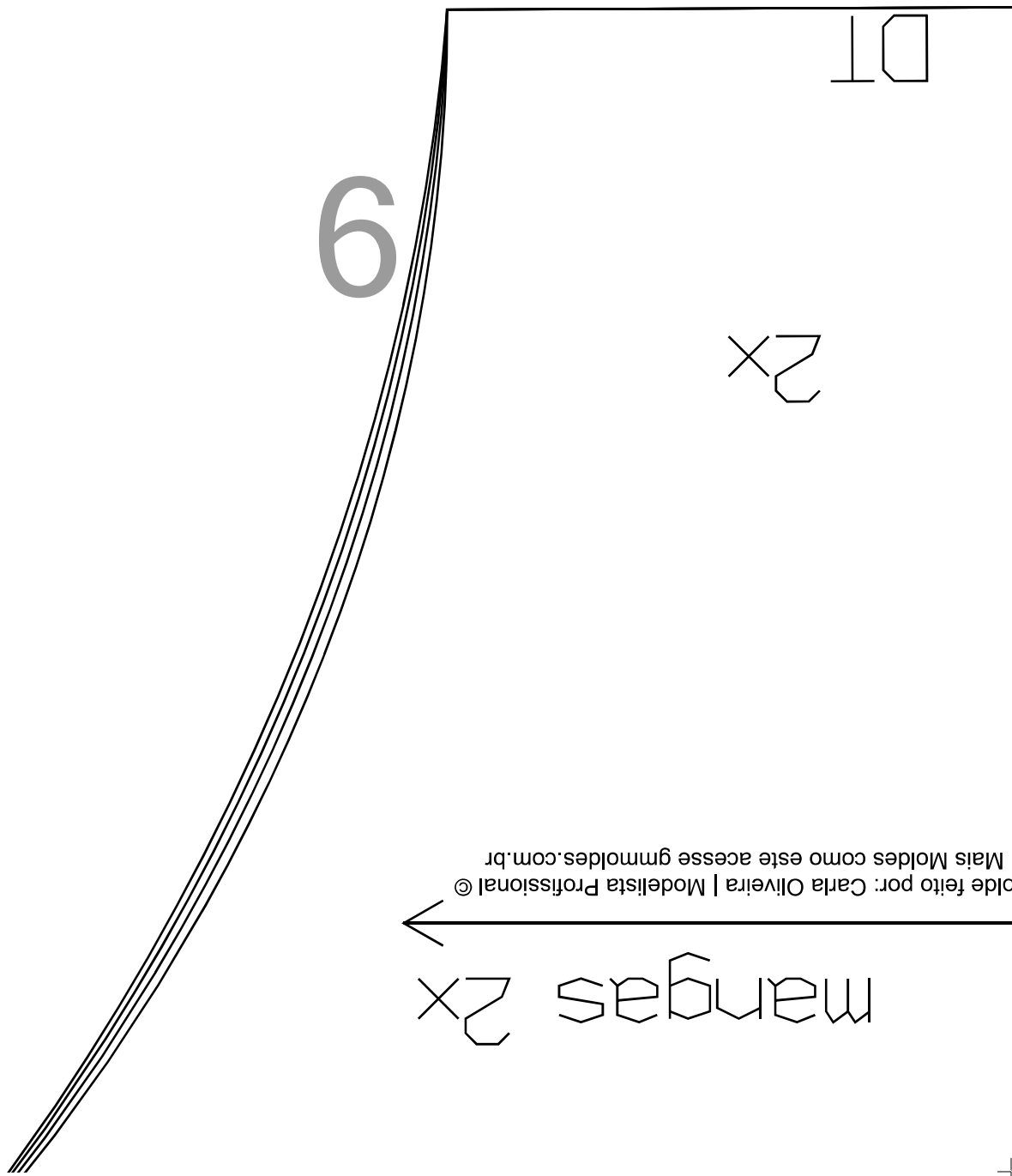

Modelo feito por: Carla Oliveira | Modelista Profissional ©
Mais Moldes como este acesse gmmoldes.com.br

accabame

Molde feito por: Carla Oliveira | Modelista
Mais Moldes como este acesse gmmmo

7

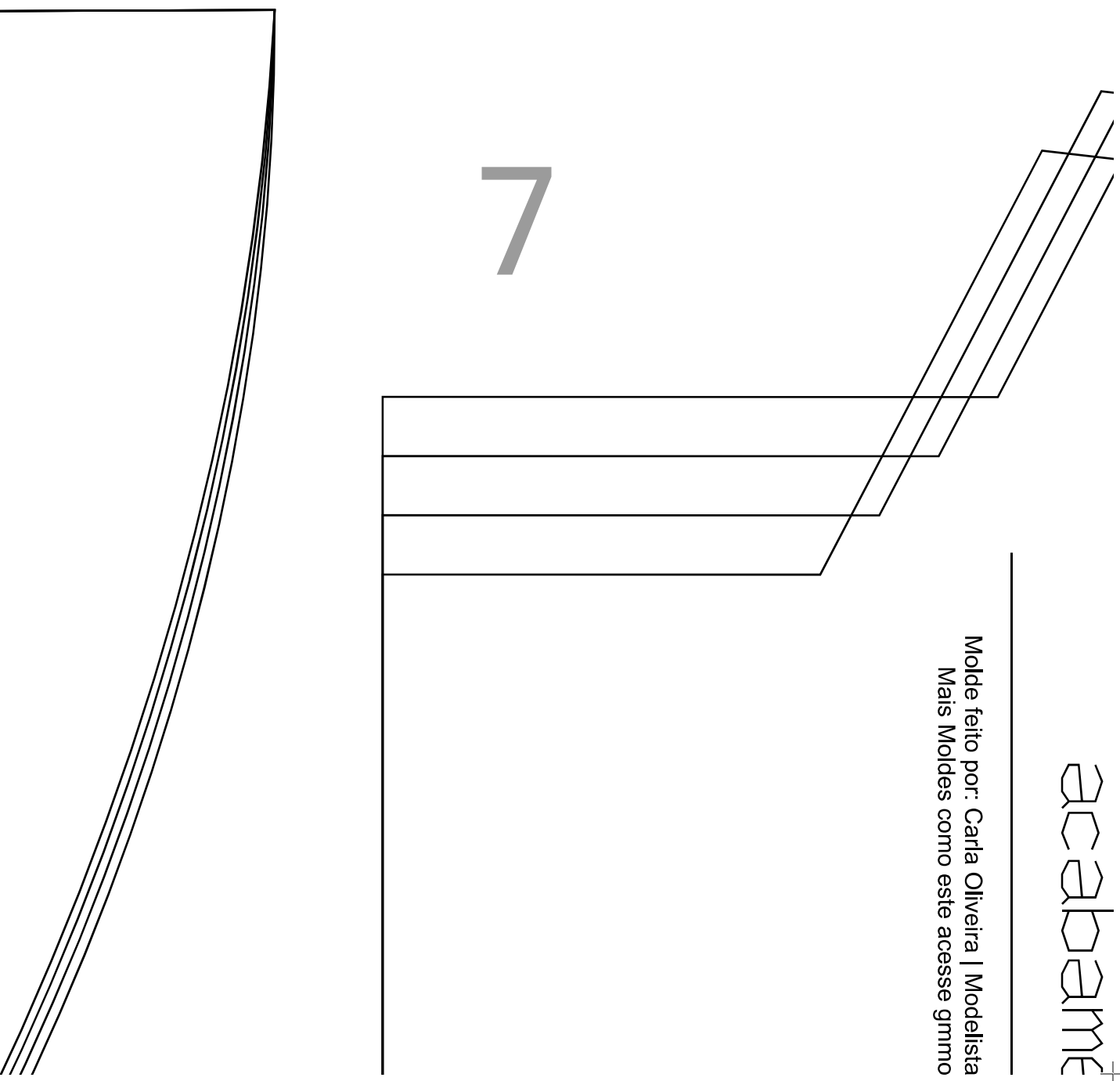

Mk I

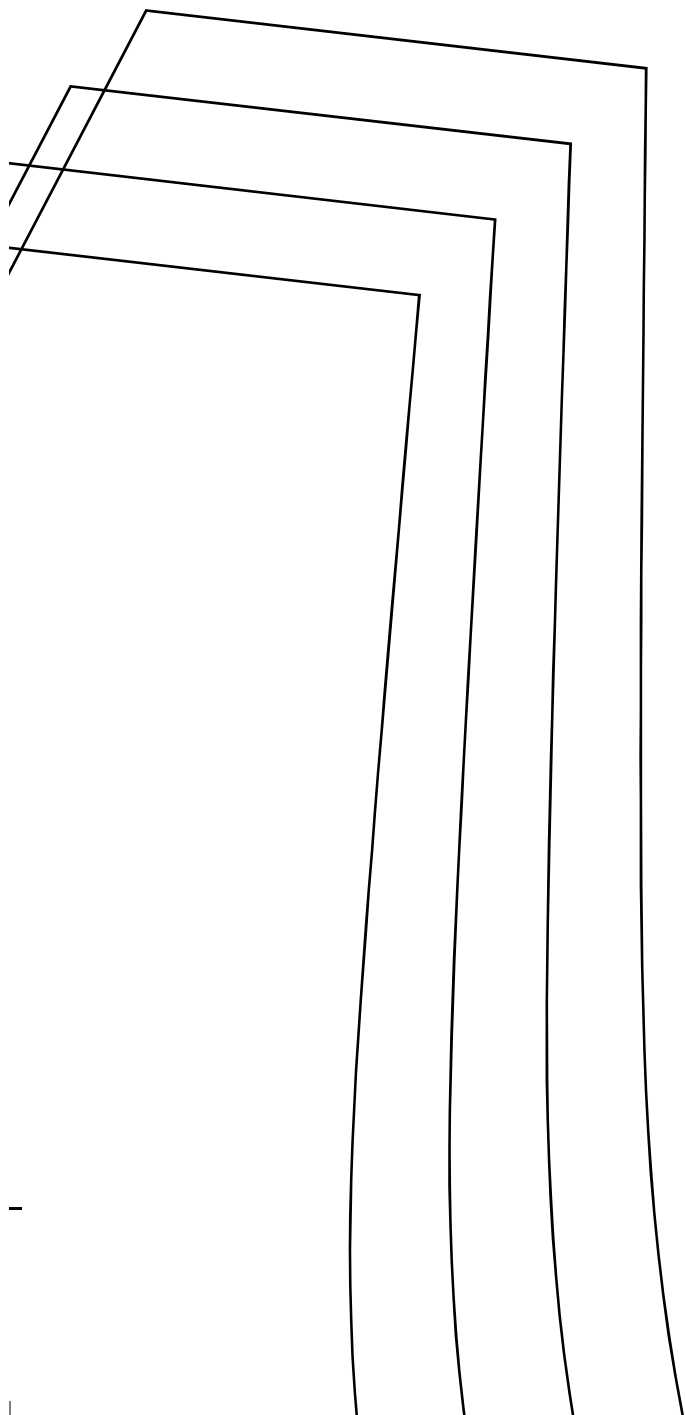

8

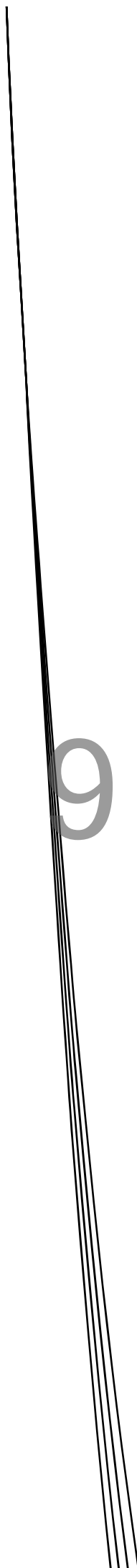

9

pedlista Profissional ©
; gmmolde.com.br

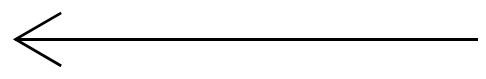

ERFOR

Molde feito por: Carla Oliveira | Mais Moldes como este acesse

fronte inf

10

franzir

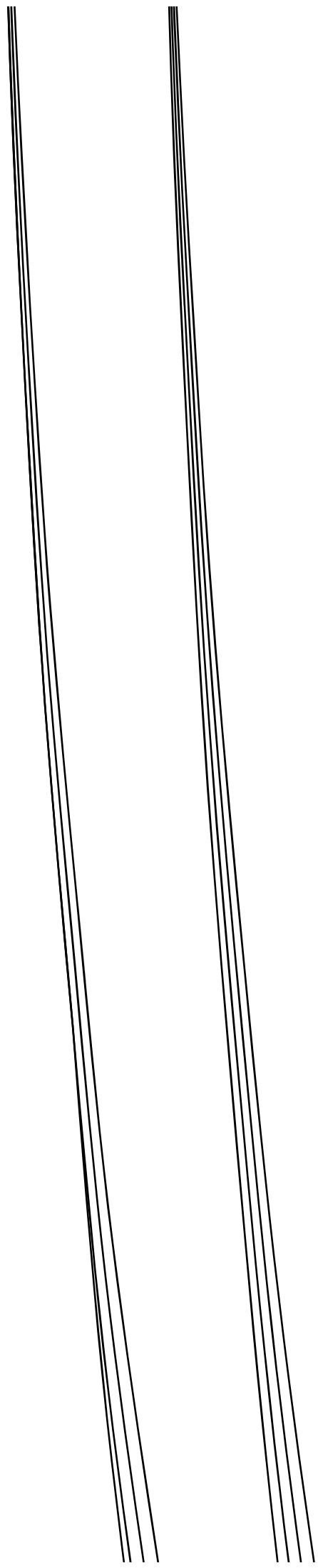

franzir

costas inferior

Molde feito por: Carla Oliveira | Modelista Profissional ©
Mais Moldes como este acesse gmmoldes.com.br

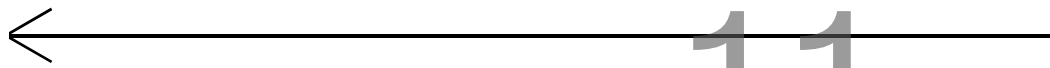



10 cm

10 cm

1 cm de costura

12

Molde feito por: Carla Oliveira | Modelista Profissional ©
Mais Moldees como este acesse gmmoldees.com.br

GG

G

M

P

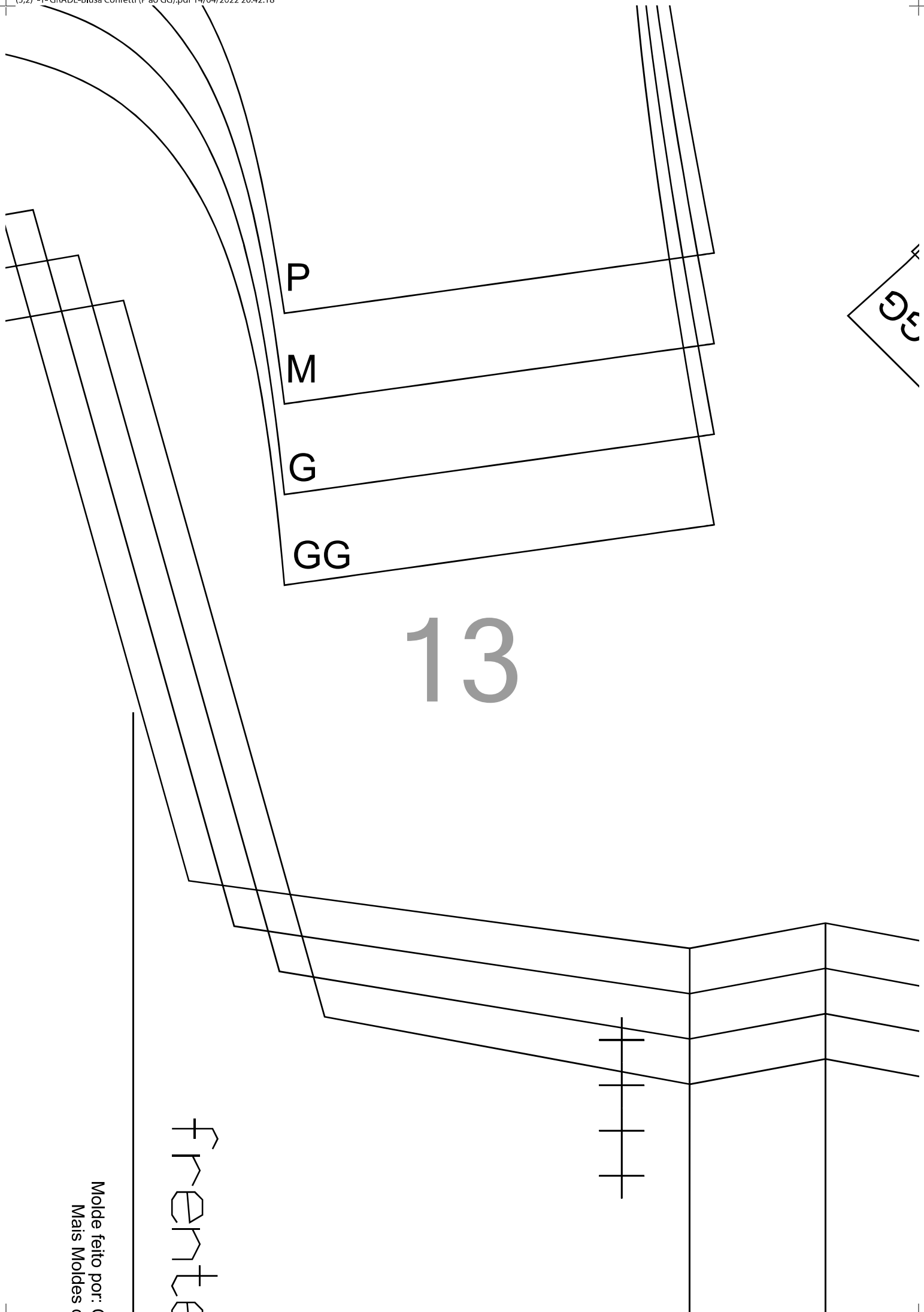

P

M

G

GG

13

GE

frente

Molde feito por: ()
Mais Moldes c

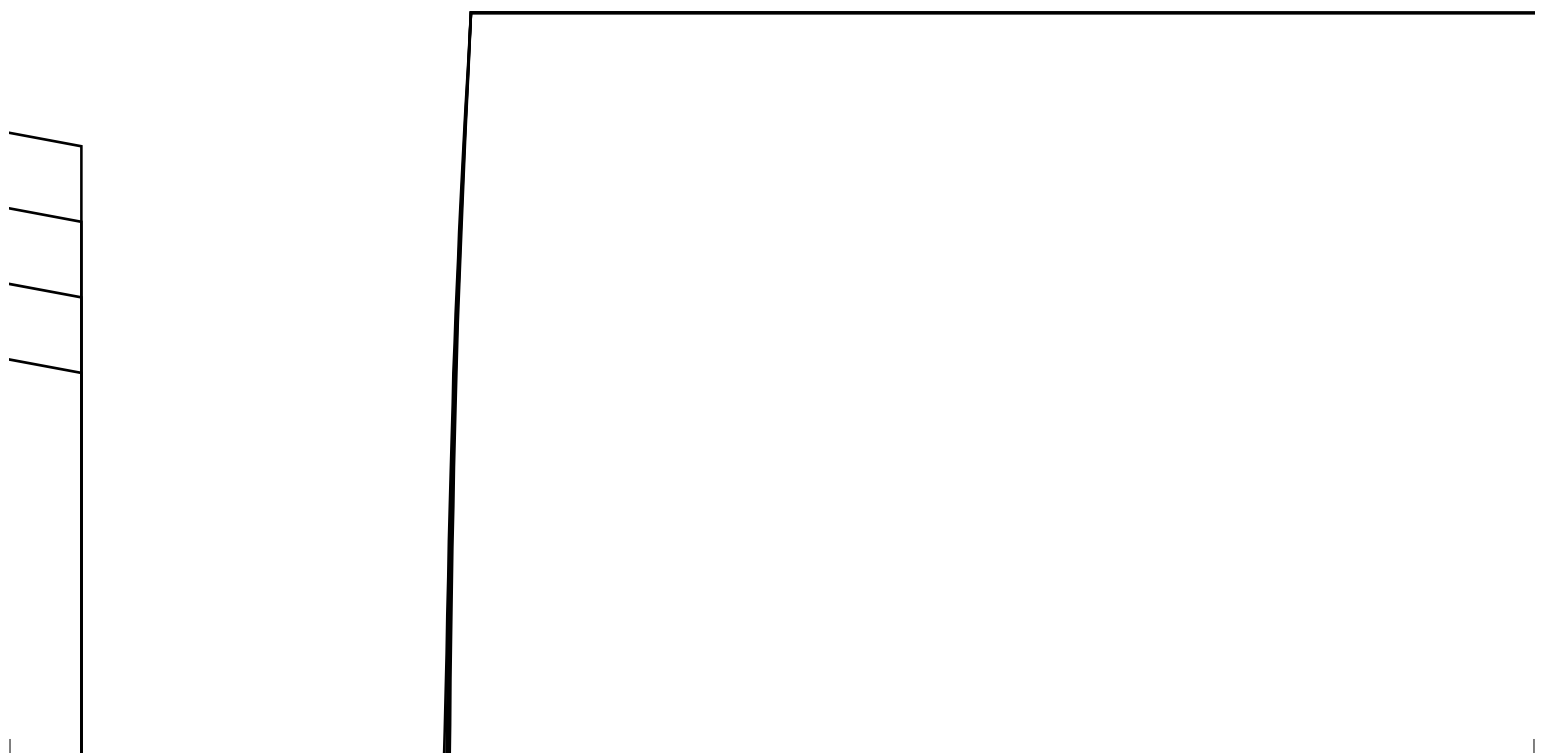
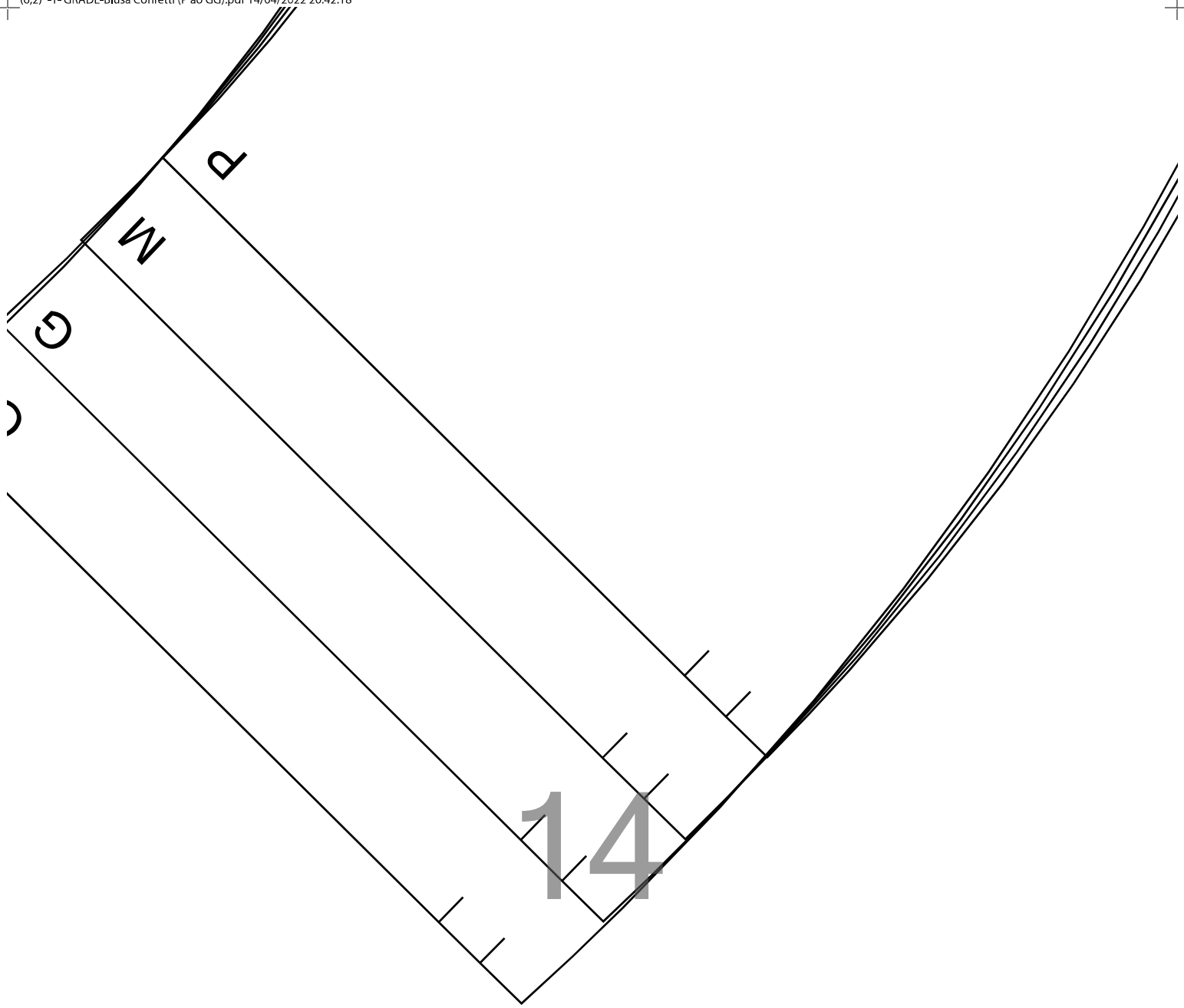

Anto Costas

Professional ©
ides.com.br



1X

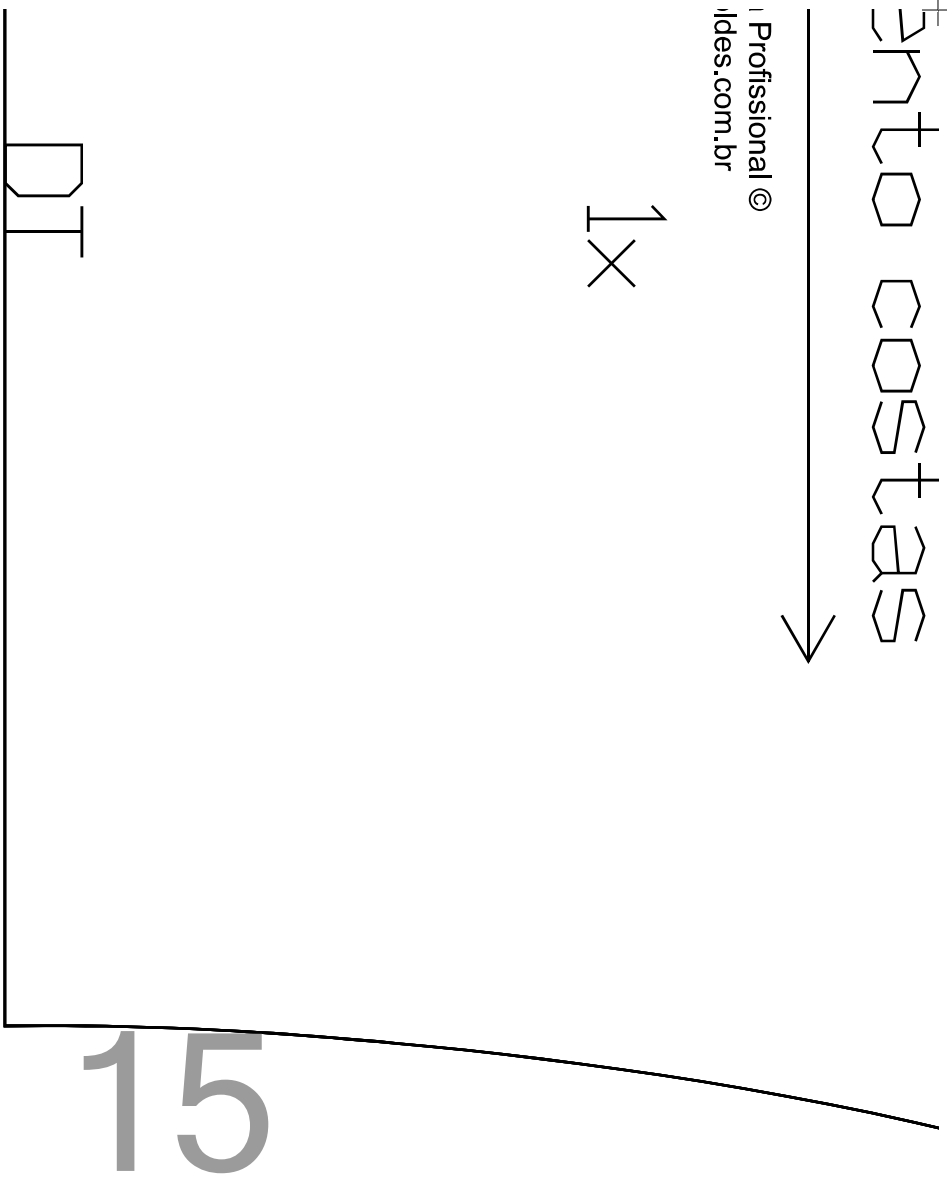

15

DT

1X

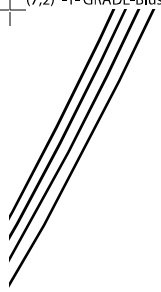

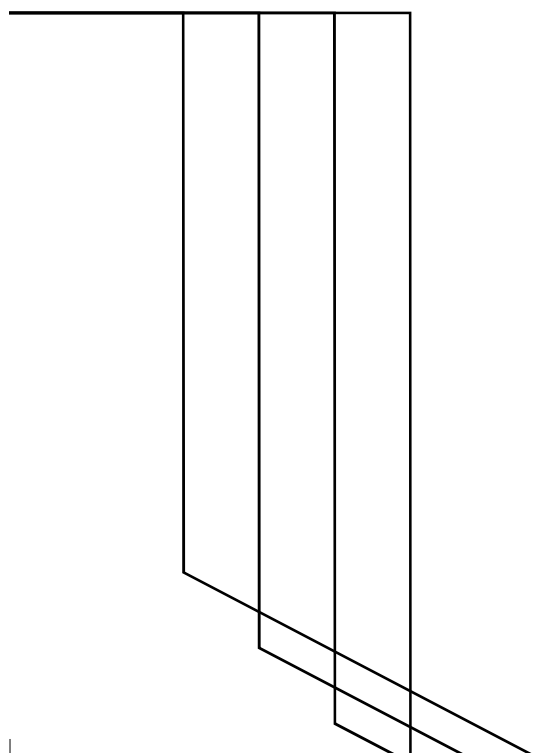
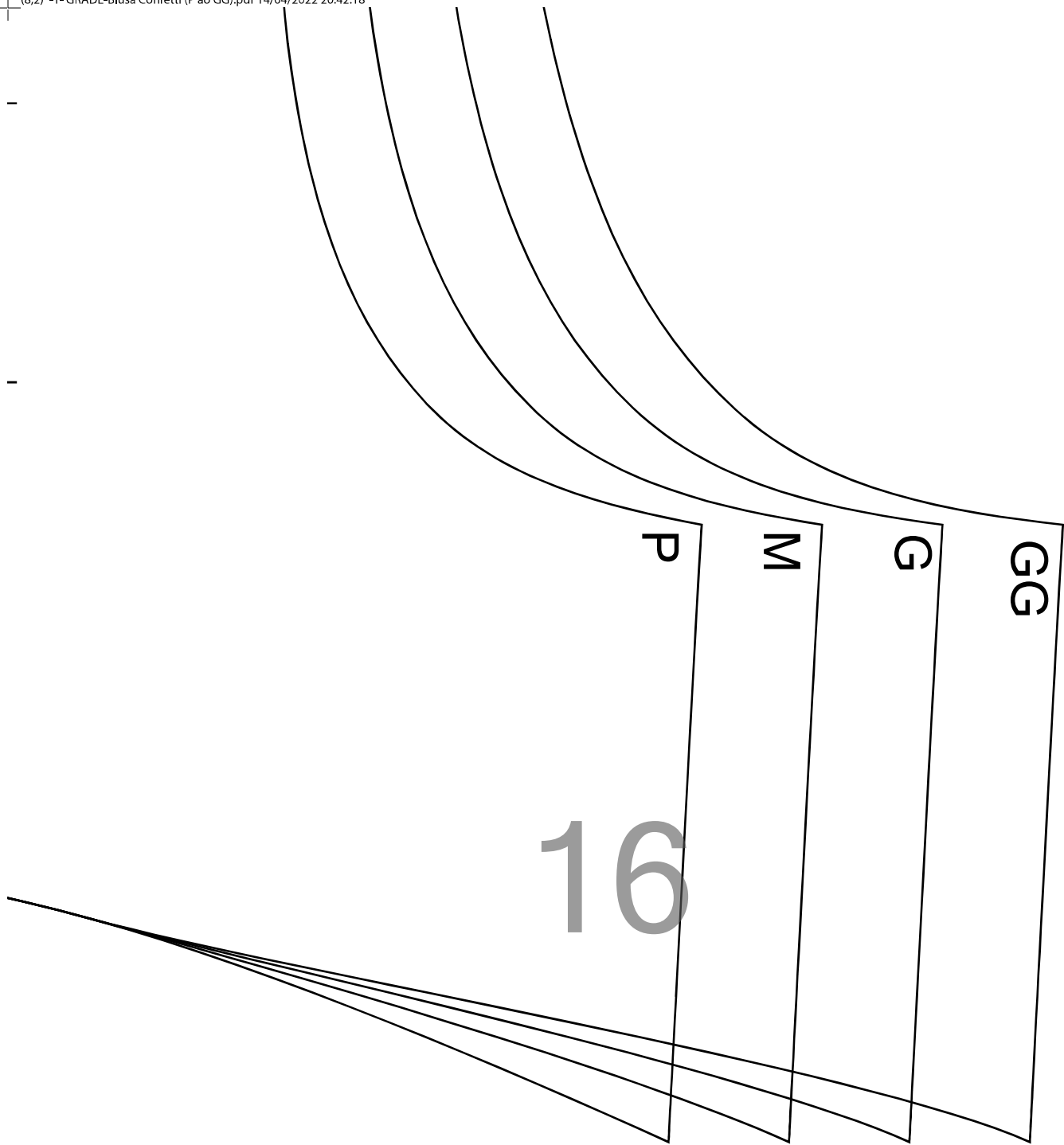

17

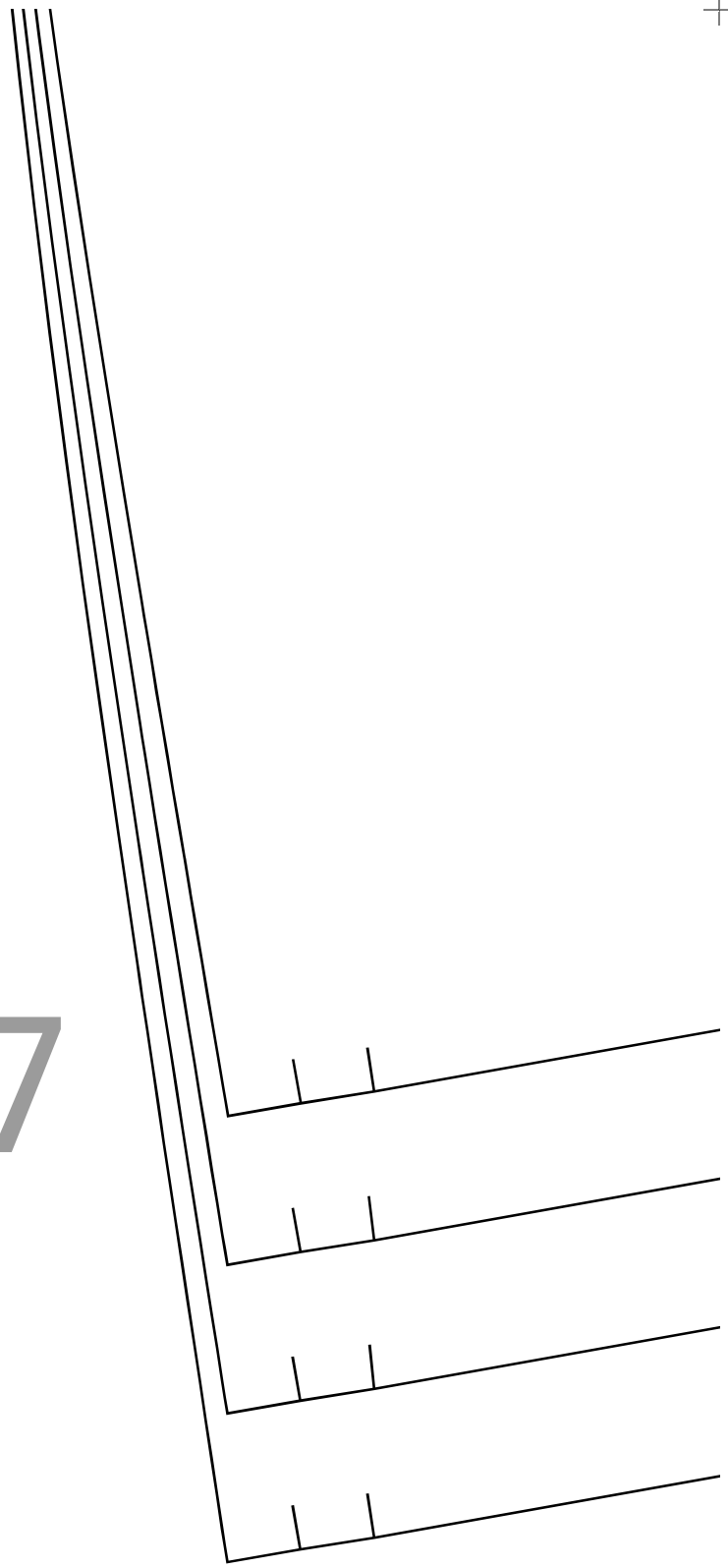

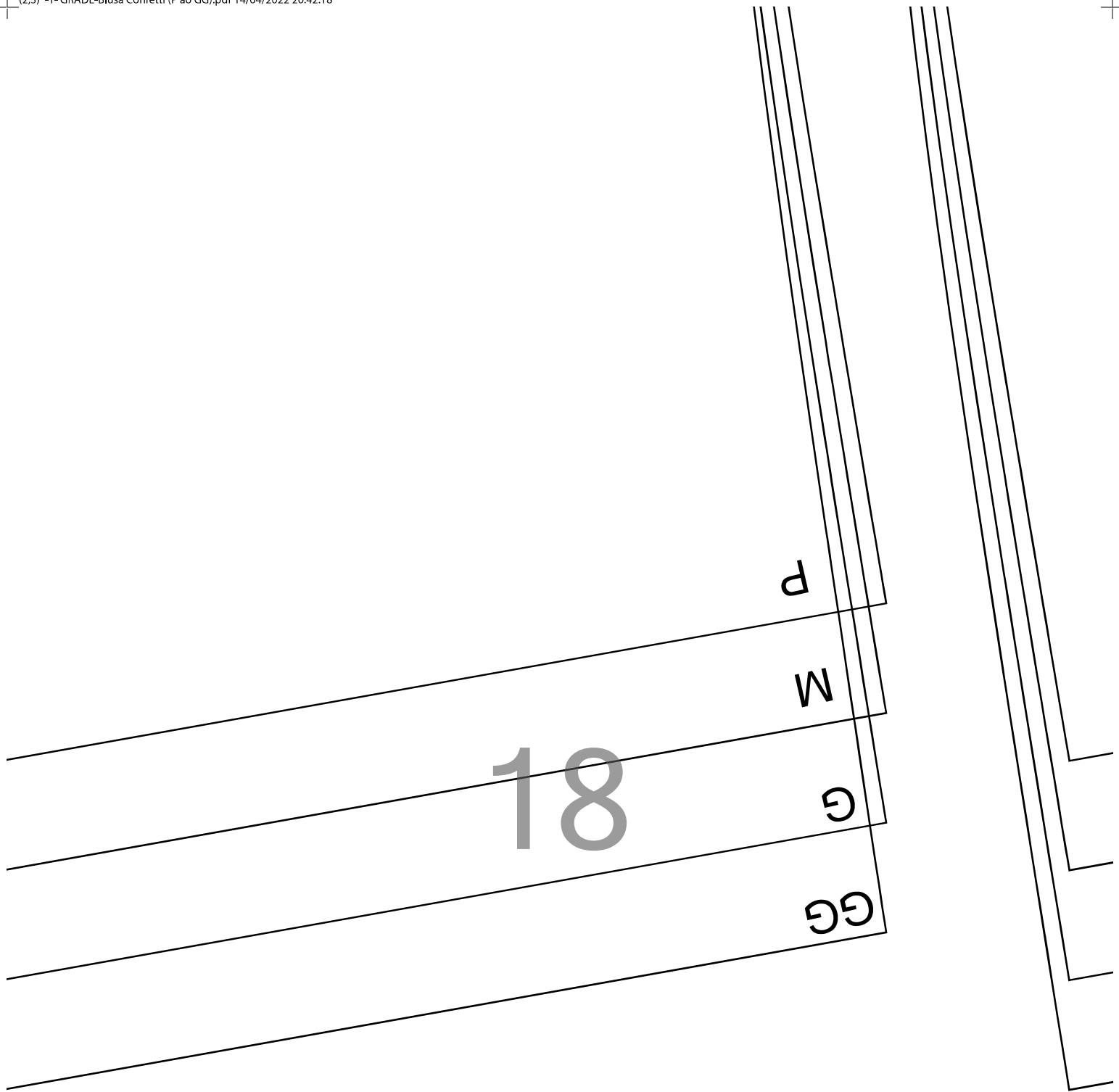



Handwriting practice lines consisting of four parallel diagonal lines sloping upwards from left to right. Each line has two short vertical tick marks at its left end. The number '19' is printed in a large, light gray font in the center of the page, overlapping the second and third lines. At the right end of the top line, the letter 'd' is written, and at the right end of the second line, the letter 'v' is written.

19

d

v

N
G
GG

20

dobrar

dobrar

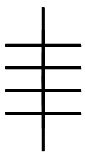
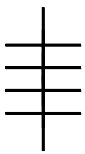
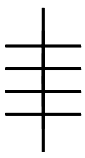

21

superior 2X



Carla Oliveira | Modelista Profissional ©
como este acesse gmmoldes.com.br

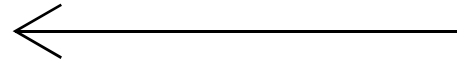

22

costas superior

